



CLASSROOM TECHNOLOGY GUIDE



Media Services

**Columbia Campus
Waymon L. Hickman
Building
Room 131
1665 Hampshire Pike
Columbia, TN 38401**

**Williamson Campus
Administration Building
Suite 220
1228 Liberty Pike
Franklin, TN 37067**

**Bob Trybalski, Coordinator
rtrybalski@columbiastate.edu
615.465.5721**

**Bill Williams, Multimedia Coordinator
wwilliams13@columbiastate.edu
931.540.2888**

**Lili Eubank, Coordinator/Theater & Event Services
leubank1@columbiastate.edu
931.540.2885**

CLASSROOM TECHNOLOGY INTRODUCTION

Audiovisual technology is provided in classrooms and labs to engage students. Operation of this equipment is standardized as best as possible to ensure easy use.

Please keep the following in mind:

- Each instructor station has a “black box” (control panel or touch screen) to operate the equipment. The manufacturer’s name, Extron or Crestron, is usually imprinted on the box.
- Display ON or System ON turns on the projector or TV. It will lower the projector screen at the same time.
- Display OFF or System OFF turns off the projector or TV. It will raise the projector screen at the same time.
- While the “black box” may differ in size or look in some classrooms, the above applies. Don’t worry about breaking anything. . .press the button or tap the icon on the screen that best represents above.
- On the rare occasions that the audiovisual equipment doesn’t turn ON or OFF, wait one-minute and try pressing the button or icon again.
- Oh, don’t forget to make sure the computer power is turned on. The computer is located inside one of the compartments of the instructor station. You will not believe the amount of times we get called for a problem and find the computer is off.



A table of contents follows.

The instructions on the following pages will guide you on the basic operation of the equipment. This guide is not intended to provide full manufacture instructions found in equipment manuals. There maybe some slight variances within the guide of equipment pictured but the application of instructions provided can be applied.

Please use the contact information at the bottom of this page if you have any questions.

Bob Trybalski, Coordinator
rtrybalski@columbiastate.edu
615.465.5721

Bill Williams, Multimedia Coordinator
wwilliams13@columbiastate.edu
931.540.2888

Lili Eubank, Coordinator/Theater & Event Services
leubank1@columbiastate.edu
931.540.2885

TABLE OF CONTENTS
Click on Hyperlink to jump to page.

- [**Control Panel found in Most Classrooms:
How to Turn ON/OFF the Projector and Other Functions**](#)
- [**Next Generation Control Panel found in Some Classrooms**](#)
- [**Next Generation Cable Cubby**](#)
- [**Lawrenceburg/STHEC Control Panel Instructions**](#)
- [**Waymon L. Hickman Building, Room 121 Instructions**](#)
- [**Franklin Humanities 109 Control Panel - Classroom Presentation**](#)
- [**Franklin Humanities 109 Control Panel - Classroom Microphones \(Not DVC\)**](#)
- [**Franklin Humanities 109 Control Panel - Livestream/DVC**](#)
- [**Franklin Humanities 111 Control Panel - Classroom Presentation**](#)
- [**Franklin Humanities 111 Control Panel - Livestream/DVC**](#)
- [**Franklin Administration 221 \(Room A\) - Control Panel for Basic Presentation**](#)
- [**Franklin Administration 221 \(Room A\) - Livestream/DVC**](#)
- [**Franklin Administration Community Room \(221 & 223 or 223 Only\)
Basic Presentation Control Panel Instructions**](#)
- [**Franklin Administration Community Room \(221 & 223\) - Microphone Instructions**](#)
- [**Franklin Administration Community Room \(223\) -
Livestream/Web Conference**](#)
- [**Warf 105 - Local Classroom Presentation \(Not Livestream/DVC\)**](#)
- [**Warf 105 - Livestream/DVC**](#)
- [**Button Control Panel in use in a few Classrooms
How to Turn ON/OFF the Projector and Other Functions**](#)
- [**Elmo Document Camera**](#)
- [**Laptop Connections on Teacher Station \(Extron Cable Cubby\)**](#)
- [**External USB Ports on Teacher Station \(Extron Cable Cubby\)**](#)
- [**Electrical Outlets on Teacher Station \(Extron Cable Cubby\)**](#)
- [**Having difficulties with equipment in the classroom? Troubleshooting Tips**](#)

Control Panel found in Most Classrooms

How to Turn ON/OFF the Projector and Other Functions



Buttons and Volume Knob

DISPLAY ON: Press *Display On* to turn on the projector and lower the screen.
 (**Warning:** 90 second warm up time; wait for button to stop blinking)

DISPLAY OFF: Press *Display Off* and then confirm action on touch screen by tapping *Power Down* icon to turn off the projector and raise the screen. Failure to confirm will cancel the action.

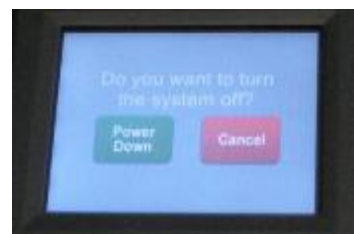

MUTE: Press the MUTE button to silence audio. Press again to return to normal.

VOLUME (Black knob under Mute button): Turn the knob to the right to increase volume. Turn it to the left to decrease volume.

SELECTING A DEVICE FOR PROJECTION: Press one of the following buttons to project that device.

1 - PC

2 - LAPTOP: *After pressing button, tap one of the icons on the touch screen to select proper cable. See next page for explanation of touch screen.*

4 - AUXILARY (*Not functional—future use*)

5 - DOC Camera (Elmo document camera).

Control Panel found in Most Classrooms Continued

Touch Screen Functions

Home Screen: The home screen displays the classroom location and Columbia State logo. Tapping the home screen has the same affect as pressing the *Display On* button. It will lower the screen and turn on the projector.



Laptop Screen: After pressing the *Laptop* button, the touch screen will change to give two input cable options. Tap the icon of the cable connected to the laptop.

Any mobile device that accepts an HDMI type cable may be plugged in to the projection system. Tap the appropriate icon to project on the screen.



PIC MUTE: Tap the *Pic Mute* icon to temporarily dim the projector bulb and raise the screen (the projector does not turn off). Tap the icon again to return to normal.

This icon appears on every screen of the device selected for projection.



Next Generation Control Panel found in Some Classrooms

Touch Screen Functions

Home Screen: The home screen displays the classroom location and Columbia State logo. Press the logo to begin which turns on the projection system.

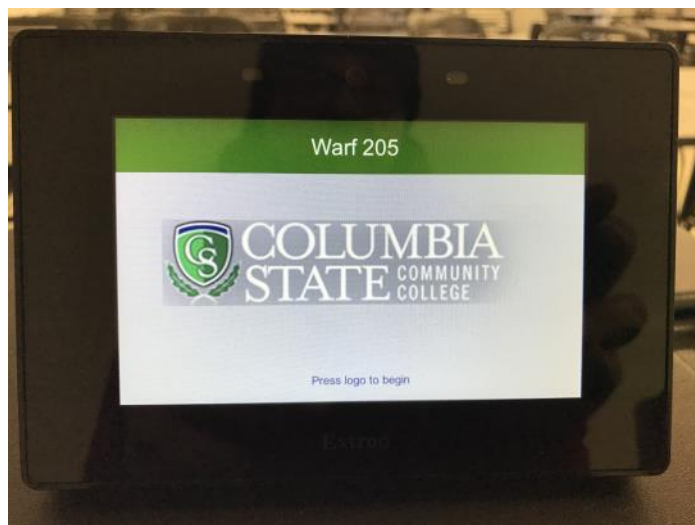

Projecting a Device: Press one of the following icons to project the device on the projection screen or TV.

1 - PC

2 - LAPTOP

4 - DOCUMENT CAMERA
(Elmo document camera)

3 - AUX INPUT (*Not in use*)

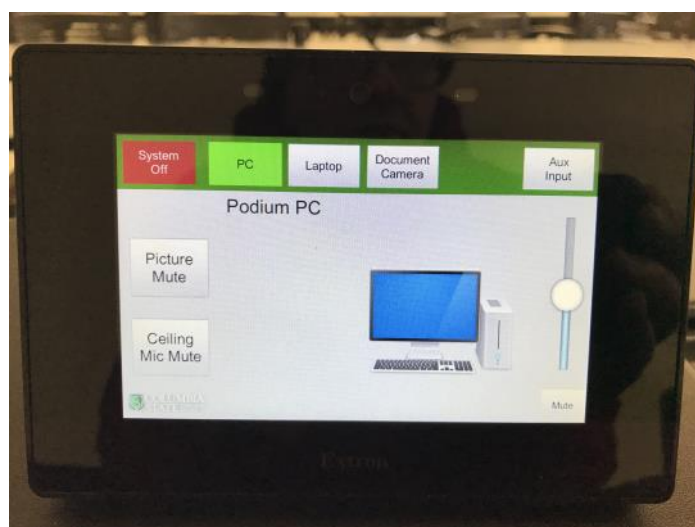

PICTURE MUTE: Tap the *Pic Mute* icon to temporarily dim the projector bulb and raise the screen (the projector does not turn off). Tap the icon again to return to normal.

CEILING MIC MUTE

Tap the icon to mute the ceiling microphone. Tap again to unmute.

SOUND VOLUME CONTROL

Move the slider above the Mute icon to adjust the sound volume up or down. Tap the Mute icon to mute the audio. Tap again to unmute.



(Continued on next page.)

Next Generation Control Panel (Continued)

Touch Screen Functions

SYSTEM OFF:

STEP 1 - Tap the System Off icon to begin the process of turning off the projection system.

Note: This does not log off the computer and logging off the computer does not turn off the projection system. They are two separate actions.

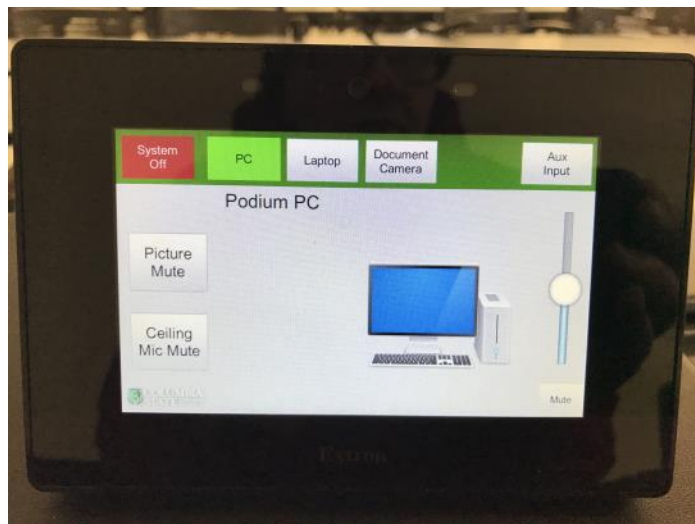

STEP 2 - Tap the YES icon to confirm the action of turning off the projection system. Tap the NO icon to continue using the projection system in the ON state.

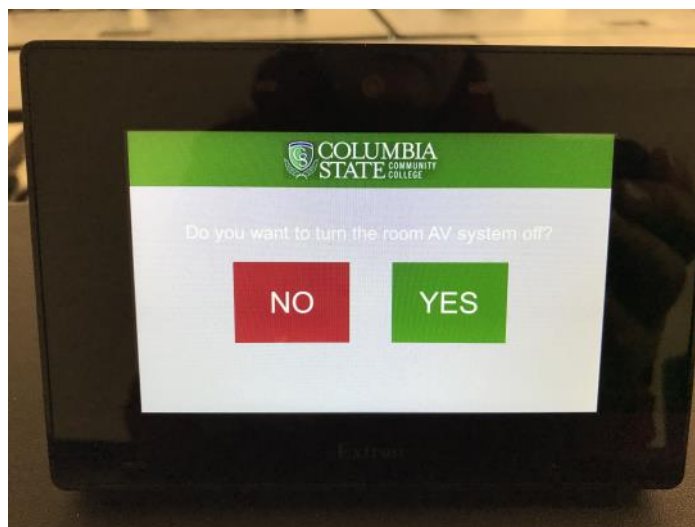

Next Generation Cable Cubby

Cable Cubby

Laptop connection, wired Internet connection, power outlet, and USB port

Lift the black metal cover to reveal the HDMI cable for laptop connection, wired Internet connection, power outlet, and the instructor station's computer extended USB port.



Laptop or Mobile Device Connection

Pull the HDMI cable up and out.
Connect it to the HDMI port on the device.

Note that any mobile device that accepts an HDMI type cable may be plugged in to the projection system using the cubby's HDMI cable.

Press the **PRESS** button above the cable to retract the cable to its home position.



Pull the Internet cable up and out.
Connect it to the Internet port on the device.

Press the **PRESS** button above the cable to retract the cable to its home position.



(Continued on next page.)

Next Generation Cable Cubby (Continued)

Laptop connection, wired Internet connection, power outlet, and USB port

Lift the black metal cover to reveal the HDMI cable for laptop connection, wired Internet connection, power outlet, and the instructor station's computer extended USB port.



Laptop or Mobile Device Connection

Pull the HDMI cable up and out.
Connect it to the HDMI port on the device.

Note that any mobile device that accepts an HDMI type cable may be plugged in to the projection system using the cubby's HDMI cable.

Press the **PRESS** button above the cable to retract the cable to its home position.



Pull the Internet cable up and out.
Connect it to the Internet port on the device.

Press the **PRESS** button above the cable to retract the cable to its home position.



(Continued on next page.)

Next Generation Cable Cubby (Continued)

USB Port

The cubby's USB port is connected to the teacher station's computer. You may plug a USB thumb drive or clicker receiver into this port. ***This port is not a phone charger.***



AC Electrical Outlet

This outlet may be used for electronic device.



Lawrenceburg/STHEC Control Panel

1. Follow prompt on Extron Control Panel to turn on projection or TV system.



2. Tap the icon of the device you want to project on the screen or TV. Note that the control panel screen display different options based on the device you select.

Lawrenceburg/STHEC Control Panel Continued

Each device page on the control panel will have common controls.

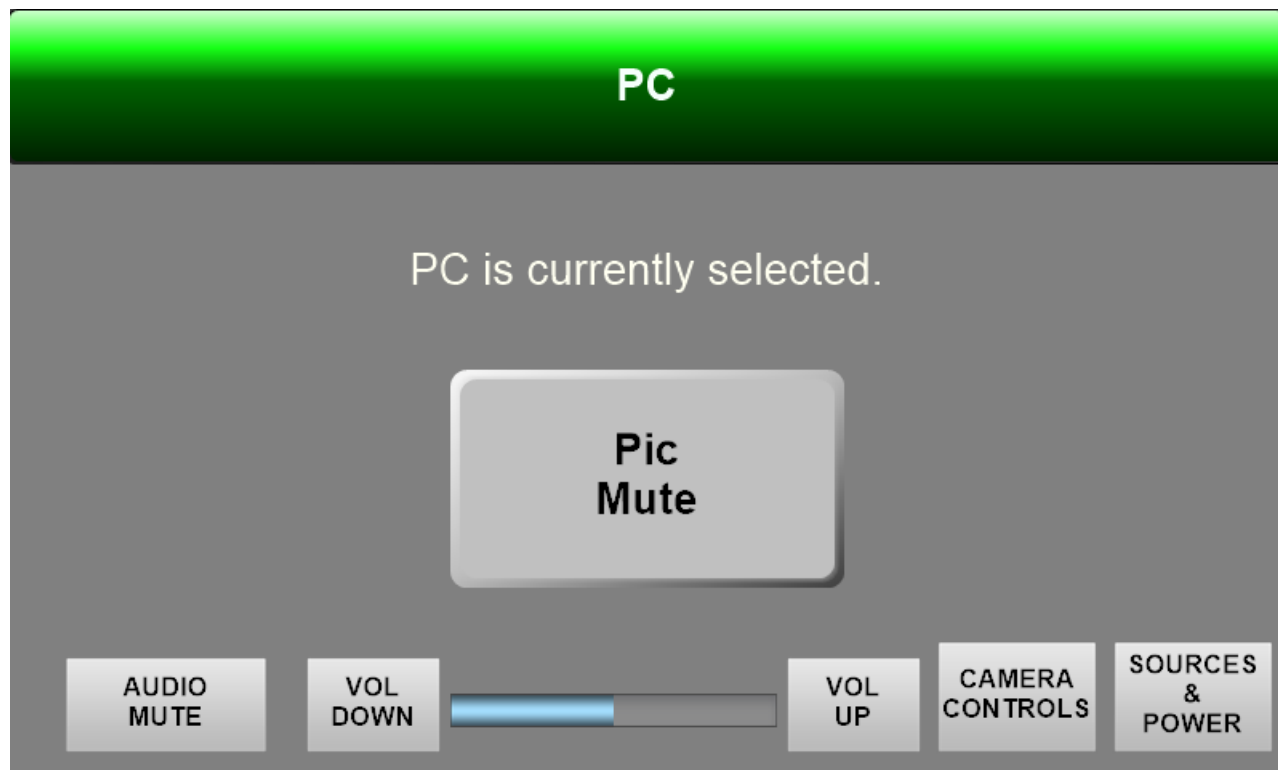

- ◆ Tap **Pic Mute** to blank the projection and raise the screen to use the whiteboard
- ◆ Tap **AUDIO MUTE** to silence the room speakers
- ◆ Tap **VOL DOWN** to decrease audio level on the room speakers
- ◆ Tap **VOL UP** to increase audio level on the room speakers
- ◆ Tap **CAMERA CONTROLS** to bring up a menu to control the live streaming camera
- ◆ Tap **SOURCES & POWER** to switch to bring up a menu to select a different device to project or to power off the projector.



Notes:

You have to use a USB cable to connect the DOC CAM to the computer to use in Zoom meeting.

The BLU-RAY will play DVD discs in the classroom but not on Zoom.

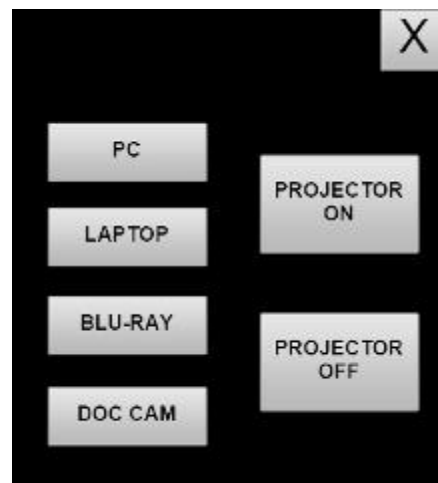

Lawrenceburg/STHEC Control Panel Continued

This page will appear when you select **LAPTOP**.



- ◆ Connect the appropriate cable from the cubby on the teacher station (similar to what is pictured to the left).
- ◆ Then tap the icon for that cable to project the laptop on the screen or TV.

Lawrenceburg/STHEC Control Panel Continued

This page will appear when you select **Blu-Ray**.



The symbols on the icons are the universal symbols for DVD/BLU-RAY player control. Tap the appropriate icon for the action you want. The More... icon will reveal an additional menu that will allow you to scroll through a disc's menu (i.e. scene selection) and select the function.

Note that the Blu-Ray player does not play videos in Zoom. You must use the PC disc drive to stream a DVD in a Zoom meeting. The PC cannot play a Blu-Ray disc.

Lawrenceburg/STHEC Control Panel Continued

Blu-Ray continued. This is the **More...** menu.



Tap the appropriate arrow to move through the Blu-Ray or DVD menu and land on the selection you want to make. Press OK to select the menu item.

WAYMON L. HICKMAN BUILDING, ROOM 121 EQUIPMENT INSTRUCTIONS

The following instructions explain the functions of the Crestron control panel.

Presentation mode - used when lecturing in the room only - are on this page.

The next page explains *Video Conference* mode - used for Desktop Video Conference (DVC).

PRESENTATION MODE

- 1) Tap the Crestron screen to wake it up and follow instruction to begin
- 2) Select Presentation mode
- 3) The screen will change to the Presentation control page



- 4) Select a source to display by tapping the corresponding icon
NOTE: *This is an Extended Desktop Display system. Programs other than PowerPoint (i.e., Internet Explorer or You Tube) will need to be "dragged" from monitor 1 to monitor 2 to display on the room's TV screens. Place the cursor on the bar at the top of the program. Using the left click on the mouse, hold down the left click key and drag the program to the second monitor.*



- 5) Power off the system by tapping the power icon and answering the question. You can mute the video by tapping the Video Mute icon. Volume is controlled by tapping the speaker icons.

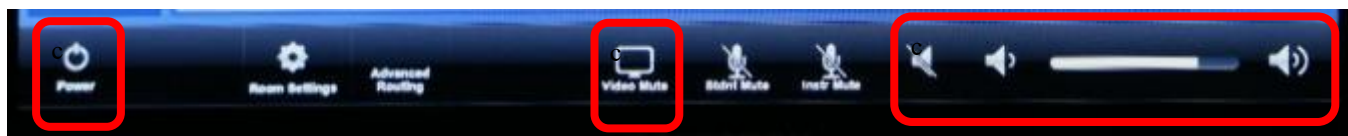

WAYMON L. HICKMAN BUILDING, ROOM 121 EQUIPMENT INSTRUCTIONS CONTINUED

The following instructions explain the *Video Conference* mode - used for Desktop Video Conference (DVC). This is used when using the Zoom software.

VIDEO CONFERENCE MODE

- 1) Tap the Creston screen to wake it up and follow instruction to begin
- 2) Select Video Conference mode
- 3) The screen will change to the Video Conference Control page



NOTE: This is an Extended Desktop Display system. When using the PC, programs other than PowerPoint (i.e., Internet Explorer or Online Campus—you can't play a video when in DVC mode) will need to be "dragged" from monitor 1 to monitor 2 to display on the room's TV screens. Place the cursor on the bar at the top of the program. Using the left click on the mouse, hold down the left click key and drag the program to the second monitor.

The touch screen is used to control the system as follows.

- **VC Displays:** tap the PC icon to display the computer. Tap the Document Camera icon to display the document camera. (NOTE: Please stop sharing your screen so that the far site can see the doc cam full screen.)
- **In/Out:** tap *In* to zoom the camera in and tap *Out* to zoom the camera out
- **Instructor/Student:** tap Instructor icon to broadcast the instructor camera. Tap the Student icon to broadcast the student camera. Icons P1, P2, P3, P4, & P5 are preset views for each camera.
- **Black Circle with Dots:** tap one of the dots to move the selected camera (up, down, left, or right)
- **Power Icon:** tap the Power icon to turn off the system. Tap Shutdown to power off. Tap Cancel to return to previous page.
- **Video Mute:** you can mute the video by tapping the Video Mute icon. Nothing will display. Tap again to display video.
- **Stdnt Mute:** tap the icon to silence the student microphones in Hickman 121. Tap again to un-silence.
- **Instr Mute:** tap the icon to silence the instructor microphone in Hickman 121. Tap again to un-silence.
- **Speaker Icons:** Mute, Decrease Speaker Volume, and Increase Speaker Volume. Tap the appropriate icon to control Hickman 121 speaker volume.

FRANKLIN HUMANITIES 109 CONTROL PANEL CLASSROOM PRESENTATION

1. Move your hand in front of control panel to wake it up. Then tap the *Touch here to begin* icon.



2. Tap *Sargent 109 ONLY* if teaching in room 109.

Tap *Sargent 109 & 111 Combined* if you are presenting to the larger space. The room partition will be open to combine both classrooms.

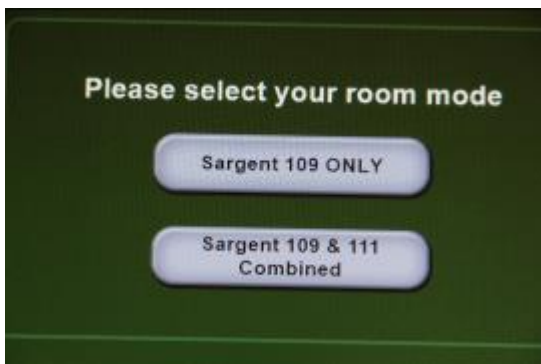

3. The home control screen will appear after warm up.



4. Tap one of the icons to project that device on the screen.



The *Laptop Digital* cable and *Laptop Analog* cable is located in a cubby to the left of the control panel.

The buttons on the sides of the control panel have the same function as the icons.

Use the *volume control knob* to adjust room volume.



5. Tap the *System Off* icon to shutdown the system



6. Tap the *Power Down* icon to turn the system off or *Cancel* to continue using the system.

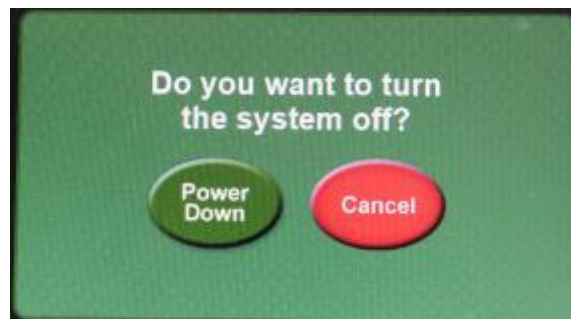

FRANKLIN HUMANITIES 109 CONTROL PANEL CONTINUED

ROOM MICROPHONES and DESKTOP VIDEO CONFERENCE (LIVE STREAMING)

Microphone Instructions

Note: Microphones are stored in soft cases inside the presentation station. There is one hand held microphone and one lapel (lavaliere) microphone.

Each microphone has a MUTE button. Press the button once. A green light will indicate that it is ON. Press and hold MUTE button 3 seconds to turn it OFF.



The microphones may be used without using the presentation equipment. The following instructions are used whether or not the projector is used.

1. Press the *Mic Control* button.
2. The Microphone Control page opens.

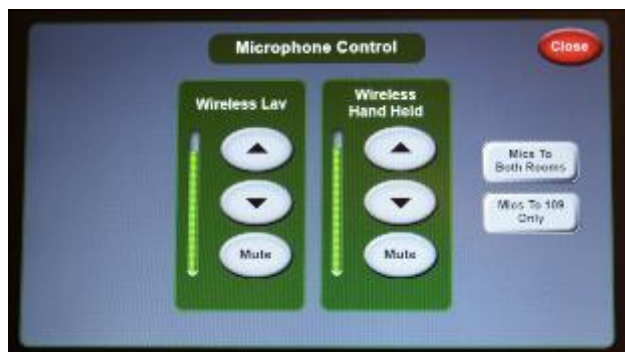

- Tap Mics To Both Rooms icon if using the large space or Mics to 109 Only icon if using the smaller space (room partition is closed).

- Tap the *UP arrow* icon to increase volume or the *DOWN arrow* icon to decrease volume. Tap *Mute* icon to mute the microphone.

-Tap the *Close* icon to exit the page

Web Camera System Instructions

Note: This is the system used for Desktop Video Courses (DVC). The following instructions guide the operation of the camera system.

1. Tap the Web Stream icon.

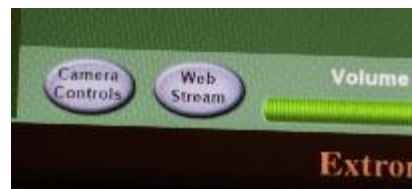

2. The *Streaming System* page opens.



-Tap *Stream* to begin broadcasting the room cameras and microphones

-Tap *Stop* to stop broadcasting

-Tap *Stdnt Cam* icon to broadcast a view of the audience

-Tap *Instr Cam* icon to broadcast view of presenter

-Tap the *Vid Mute* icon to shut off the camera. Tap again to turn back on.

-Tap the *Audio Mute* icon to shut off the microphones. Tap again to turn back on.

-Tap the *UP or DOWN arrows* to adjust the microphone volume.

-Tap the *Close* icon to exit the page.

-Tap the *Camera Controls* icon for camera control

NOTE: The microphones hanging from the ceiling are used for the desktop video conference/live streaming.

FRANKLIN HUMANITIES 111 CONTROL PANEL CLASSROOM PRESENTATION

1. Move your hand in front of control panel to wake it up. Then tap the *Press Logo to Begin* icon.



2. The home control screen will appear after system warm up.



IMPORTANT NOTE: You will not be able to use the system if a user in Room 109 accidentally or purposely placed the system in combined mode. Room 109 is the “control room” when room 109 & 111 are combined (room partition is open). The following message will appear when in combined mode:



3. Tap one of the icons to project that device on the screen.



The *Laptop Digital* cable and *Laptop Analog* cable is located in a cubby to the left of the control panel.

The buttons on the sides of the control panel have the same function as the icons.

Use the *volume control knob* to adjust room volume.



4. Tap the *System Off* icon to shutdown the system



Tap the *Power Down* icon to turn the system off or *Cancel* to continue using the system.

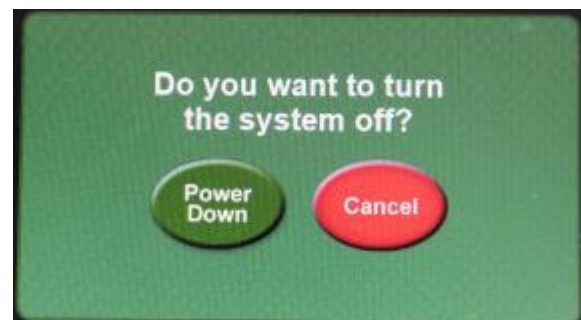

FRANKLIN HUMANITIES 111 CONTROL PANEL CONTINUED

DESKTOP VIDEO CONFERENCE (LIVE STREAMING)

Web Camera System Instructions

Note: This is the system used for Desktop Video Courses (DVC). The following instructions guide the operation of the camera system.

1. Tap the Web Stream icon.

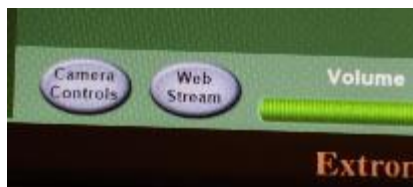

2. The *Streaming System* page opens.



-Tap *Stream* to begin broadcasting the room cameras and microphones

-Tap *Stop* to stop broadcasting

-Tap *Stdnt Cam* icon to broadcast a view of the audience

-Tap *Instr Cam* icon to broadcast view of presenter

-Tap the *Vid Mute* icon to shut off the camera. Tap again to turn back on.

-Tap the *Audio Mute* icon to shut off the microphones. Tap again to turn back on.

-Tap the *UP* or *DOWN* arrows to adjust the microphone volume.

-Tap the Close icon to exit the page.

-Tap the *Camera Controls* icon for camera control

NOTE: The microphones hanging from the ceiling are used for the desktop video conference/live streaming.

FRANKLIN ADMINISTRATION 221 - ROOM A CONTROL PANEL BASIC PRESENTATION EQUIPMENT INSTRUCTIONS

1. Move your hand in front of control panel to wake it up. Then tap the *Press Logo to Begin* icon.



2. The home control screen will appear after system warm up.



IMPORTANT NOTE: You will not be able to use the system if a user in Room 223 accidentally or purposely placed the system in combined mode. Room 223 is the “control room” when room 221 & 223 are combined. The following message will appear when in combined mode:



3. Tap one of the icons to project that device on the screen.



The *Laptop Digital* cable and *Laptop Analog* cable is located in a cubby to the left of the control panel.

The buttons on the sides of the control panel have the same function as the icons.

Use the *volume control knob* to adjust room volume.



4. Tap the *System Off* icon to shutdown the system



5. Tap the *Power Down* icon to turn the system off or *Cancel* to continue using the system.

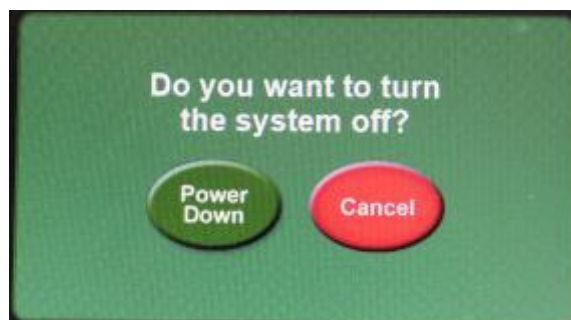

FRANKLIN ADMINISTRATION 221 - ROOM A CONTROL PANEL DESKTOP VIDEO CONFERENCE/LIVE STREAMING

Web Camera System Instructions

Note: Web conferences must be set up in advance with Media Services. The following instructions guide the operation of the camera system.

1. Tap the Web Stream icon.

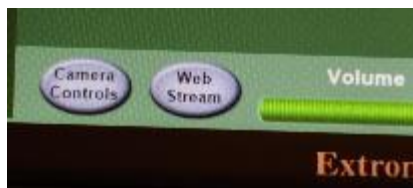

2. The *Streaming System* page opens.



-Tap *Stream* to begin broadcasting the room cameras and microphones

-Tap *Stop* to stop broadcasting

-Tap *Stdnt Cam* icon to broadcast a view of the audience

-Tap *Instr Cam* icon to broadcast view of presenter

-Tap the *Vid Mute* icon to shut off the camera. Tap again to turn back on.

-Tap the *Audio Mute* icon to shut off the microphones. Tap again to turn back on.

-Tap the *UP* or *DOWN* arrows to adjust the microphone volume.

-Tap the Close icon to exit the page.

-Tap the *Camera Controls* icon for camera control



BASIC PRESENTATION EQUIPMENT INSTRUCTIONS FOR FADM 223—ROOM B or A & B

1. Move your hand in front of control panel to wake it up. Then tap the *Touch here to begin* icon.



4. Tap one of the icons to project that device on the screen.



The *Laptop Digital* cable and *Laptop Analog* cable is located in a cubby to the left of the control panel.

The buttons on the sides of the control panel have the same function as the icons.

2. Choose **Individual Mode** if you are presenting to a small group in Room 223 only. The room partition will be closed splitting the community room in half.

Choose **Combined Mode** if you are presenting to the larger space. The room partition will be open.



Use the *volume control knob* to adjust room volume.



5. Tap the *System Off* icon to shutdown the system



Tap the *Power Down* icon to turn the system off or *Cancel* to continue using the system.

3. The home control screen will appear after warm up.

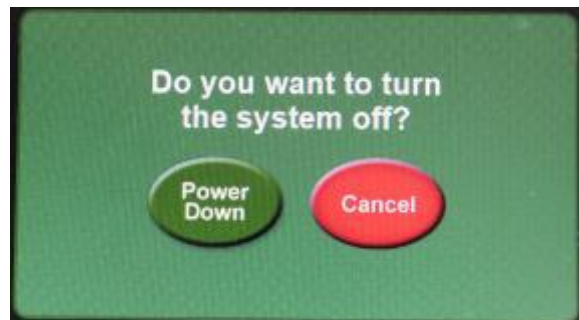



ADVANCED EQUIPMENT INSTRUCTIONS FOR FADM 223 — ROOM B

Microphone Instructions

Note: Microphones are stored in soft cases inside the presentation station. There is one hand held microphone and one lapel (lavaliere) microphone.

Each microphone has a MUTE button. Press the button once. A green light will indicate that it is ON. Press and hold MUTE button 3 seconds to turn it OFF.



The microphones may be used without using the presentation equipment. The following instructions are used whether or not the projector is used.

1. Press the *Mic Control* button.



2. The Microphone Control page opens.

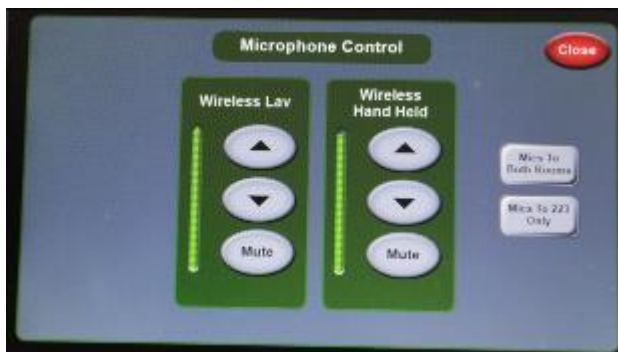

- Tap **Mics To Both Rooms** icon if using the large space or **Mics to 223 Only** icon if using the smaller space (room partition is closed).

- Tap the **UP** arrow icon to increase volume or the **DOWN** arrow icon to decrease volume. Tap **Mute** icon to mute the microphone.

-Tap the **Close** icon to exit the page

Livestreaming/Web Conference Instructions

Note: Web conferences must be set up in advance with Media Services. The following instructions guide the operation of the camera system.

1. Tap the **Web Stream** icon.

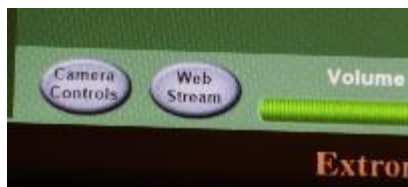

2. The *Streaming System* page opens.



-Tap **Stream** to begin broadcasting the room cameras and microphones

-Tap **Stop** to stop broadcasting

-Tap **Stdnt Cam** icon to broadcast a view of the audience

-Tap **Instr Cam** icon to broadcast view of presenter

-Tap the **Vid Mute** icon to shut off the camera. Tap again to turn back on.

-Tap the **Audio Mute** icon to shut off the microphones. Tap again to turn back on.

-Tap the **UP** or **DOWN** arrows to adjust the microphone volume.

-Tap the **Close** icon to exit the page.

-Tap the **Camera Controls** icon for camera control



WARF 105 CLASSROOM - LOCAL CLASSROOM PRESENTATION

The following instructions are for presenting to the local classroom only. DVC (Desktop Video Conference) operation instructions are on the next page.

1. Wave your hand in front of Extron panel to wake it up.
2. Touch screen to begin.
3. Tap **Local Presentation**

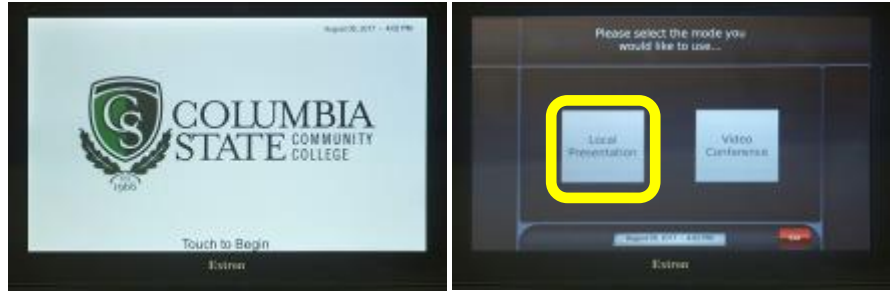

NOTE: If you find it in the Video Conference mode, tap System Off and then tap **Swap Modes** to select the Local Presentation mode.

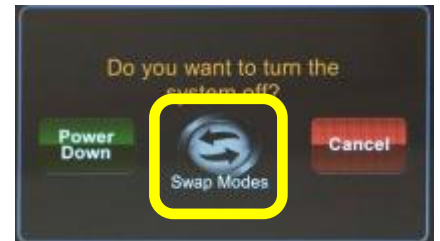
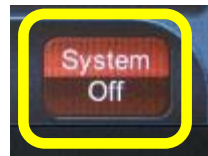

4. There are three icons at the top of the screen. Tap the icon of the device you want displayed on the TV screens.

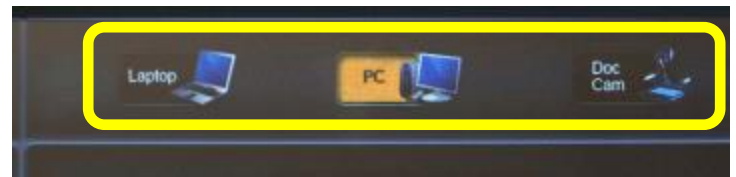

NOTE: Selecting **Laptop** or **Doc Cam** will give you additional controls. Follow the instructions on the screen. **Program Volume** controls sound levels in the room.

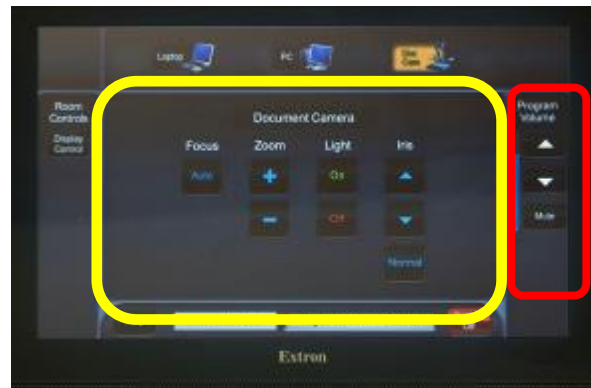
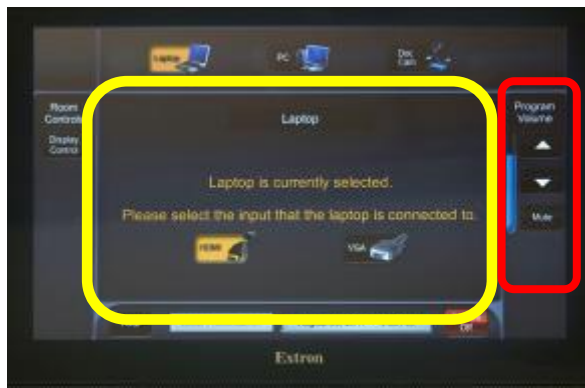

5. Tap **System Off**, then tap **Power Down** on the next screen to turn off system.

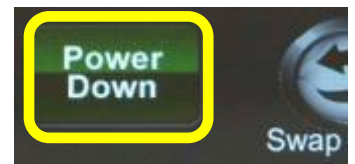
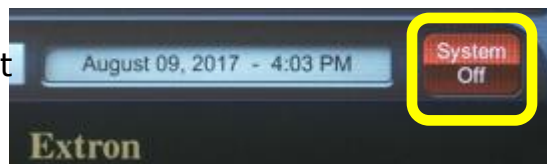



WARF 105 - DESKTOP VIDEO CONFERENCE (DVC)

The following instructions are for DVC (Desktop Video Conference). Local presentation operation instructions are on the previous page.

1. Wave your hand in front of Extron panel to wake it up.
2. Touch screen to begin.

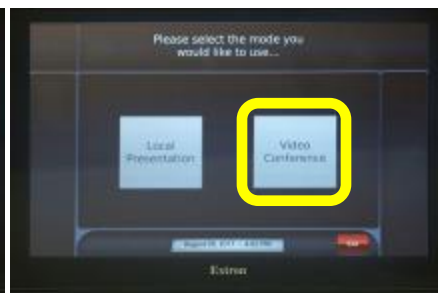

3. Tap **Video Conference**

NOTE: If you find it in the Local Presentaion mode, tap System Off and then tap **Swap Modes** to select the Video Conference mode.



4. There are four icons at the top of the screen. Tap the icon of the device you want to broadcast. **NOTE:** The PC is automatically broadcast in Video Conference mode.



NOTE: Selecting **Laptop**, **Doc Cam**, or one of the **Cameras** will give you additional controls. **PC Volume** controls sound levels in the room. The microphones can be silenced by tapping **Mute** under the appropriate microphone label (Podium Mic and/or Ceiling Mic). Camera angles can be adjusted by tapping one of the **Presets** icons, or one of the **Arrows**. The **Zoom** control, **+** and **-**, can be used to widen or shorten the field of view.

5. Tap **System Off**, then tap **Power Down** on the next screen to turn off system.

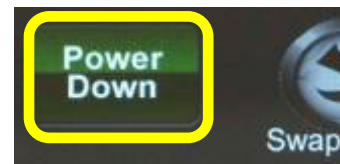
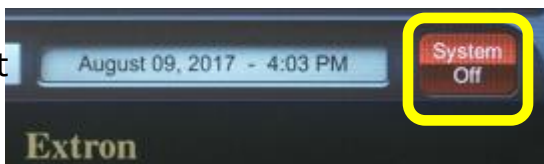

Button Control Panel in use in a few Classrooms

How to Turn ON/OFF the Projector and Other Functions



DISPLAY: **ON** - Turns on the projector and lowers the screen
(**Warning:** 90 second warm up time; wait for ON button to stop blinking)

OFF - Turns off the projector and raises the screen

VOLUME: Turn the knob to the right to increase volume.
Turn it to the left to decrease volume.
(Green lights to the left of knob will light up as volume increases.)

PIC MUTE: Press the PIC MUTE button to blank the screen. The light illuminates red.

AUTO IMAGE: Press the AUTO IMAGE button if the computer or laptop display does not look normal on the projector screen.

CC ON/OFF: Press the CC button to turn on the closed caption decoder for the DVD/VHS player. Press again to turn off this feature. This does not decode closed captioned media on the computer.

SELECTING A DEVICE FOR PROJECTION: Press one of the following buttons to project that device.

1 - **DOC Camera** (document camera)

2 - **LAPTOP**

3 - **PC**

4 - **VIDEO or DVD/VCR** (to project the DVD/VHS player)

5 - **AUX VIDEO.** Press the AUX VIDEO button when you connect an external video device's RCA output to the external video ports on the hideaway.

6 - **AUX S-VIDEO.** Press the AUX S-VIDEO button when you connect an external video device's s-video output to the S-Video port on the hideaway. The RCA audio output of the s-video device must be plugged into the RCA port on the hideaway if audio output is needed.

Elmo Document Camera

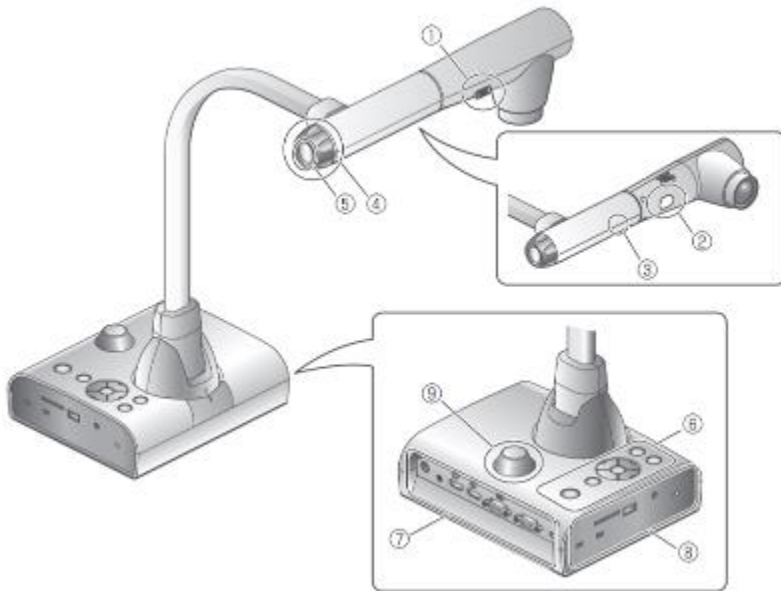

1 - ILLUMINATION SWITCH

Move the switch to the right to turn on the light (#2 in drawing). Move it to the left to turn it off.

4 - ZOOM DIAL

Rotate the dial toward you to zoom in. Rotate the dial away from you to zoom out.

5 - AF (Automatic Focus)

6 - OPERATING PANEL

See below.

OPERATING PANEL

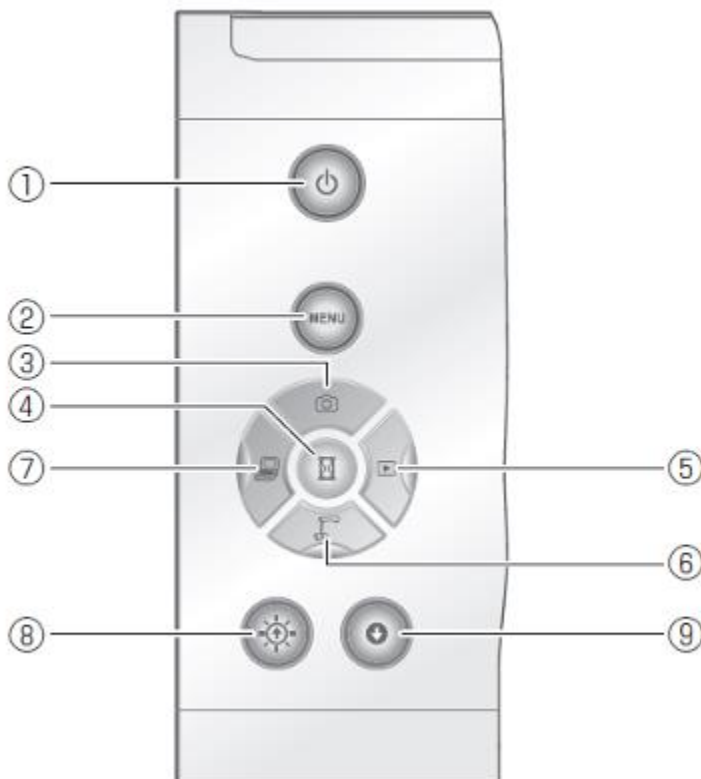

1 - POWER BUTTON

Press the power button once to turn on the document camera. The light around the button will turn blue.

Press and hold the power button for 2 seconds to turn the power off. The light around the button will turn red.

8 - BRIGHTNESS ADJUST

Press the button in increments to brighten the image.

9 - DARKNESS ADJUST

Press the button in increments to darken the image.

Extron Cable Cubby (External USB ports, and Laptop Connections)

The Extron Cubby provides external connections for the PC's USB ports, laptop connection, and other mobile devices (I-Pads, I-pods, MP3 players, and etcetera).

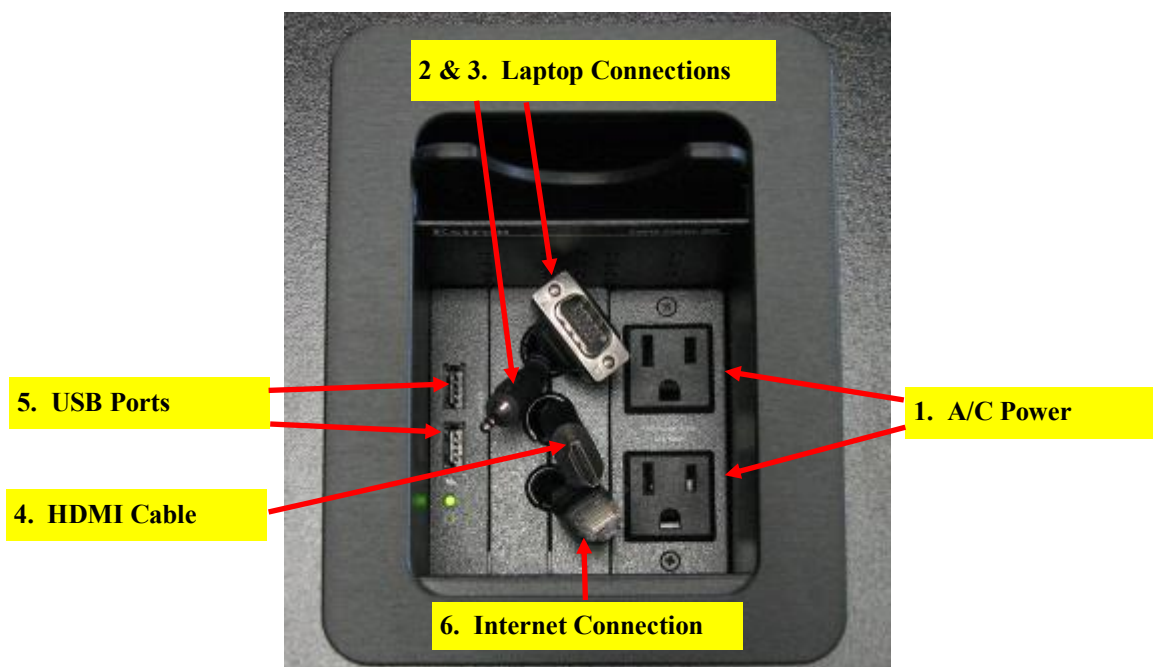

1. **A/C Power** for Laptop and other mobile devices provides 110V power.
2. **Laptop Computer Video Port.** Connect the VGA Cable into a similar looking port on your laptop. Press *DISPLAY ON* to lower screen and power on projector. Select *Laptop* on the control panel and tap the icon of the cable on the touch screen to see the device's video on projection screen.
3. **Laptop Computer Audio Port.** Plug the mini audio jack into headphone port on your laptop. You can also plug an I-Pod or MP3 player into this port. Select *Laptop* on the control panel and tap the VGA cable icon on the touch screen to hear the audio.
4. **HDMI Cable for Laptop Connection and other mobile devices.** HDMI (High-Definition Multimedia Interface) is a digital replacement for existing analog audio/video standards. Many newer computer, audiovisual, and mobile devices use this type of interface to transmit audio and video data to displays such as projectors and televisions. Plug the HDMI cable into the device, select *Laptop* on the control panel, and tap the icon of the HDMI cable on the touch screen to project and/or hear the device.
5. **USB Port for Flash Drives, USB Drive, etcetera.** Connect your USB device here for the teacher station's PC.
6. **Wired Internet Connection for Laptop Computer.** Connect the internet cable to the similar looking port on your laptop computer.

Having difficulties with equipment in the classroom?

The following troubleshooting guide may help to solve the problem. Further assistance, including a personal tutorial session, may be arranged by sending an e-mail to Media Services at mediaservices.columbiastate.edu.

Cabinet doors locked?

- The keys should be next to the computer keyboard or in the drawer.

None of the equipment is working!

- Is the master power switch, located inside the cabinet, on?
- Are all the components inside the cabinet turned on?

Projector Problems

- Have you turned on the projector using the control panel or touch screen? It is a black box mounted on the countertop. Look for the "ON" or "DISPLAY ON" button .
- Have you selected the correct input source? Press the button on the control panel that corresponds with the device you are using.

Screen Problems

- The screen will automatically lower when you press the "ON" or "DISPLAY ON" button on the countertop control panel.
- Try pressing the "ON" or "DISPLAY ON" button again after the projector is on and the button stops blinking.

Computer Problems

- Have you turned the computer power on?
- Have you turned on the power to the monitor?
- Have you "logged on" to the network?
- Is the computer not projecting? Check to see if the projector is turned on and the correct input source (PC) is selected on the control panel.
- Volume problem? Use the control panel's volume knob to adjust the sound.
- Double-click the speaker icon on the computer's taskbar to adjust the output volume.

Document Camera/Visual Presenter (Elmo)

- Is the power turned on? On some models, the power switch is located in the rear of the document camera near the power cord.
- Is the document camera not projecting? Check to see if the projector is turned on and the correct input source (DOC CAM) is selected on the control panel.
- Is the document dark? Check to see if the lamp is turned on. Also, you may need to adjust the iris.
- Is the document bright? Try turning off the lamp and/or adjusting the iris.
- Is the document out of focus? Try pressing auto-focus or manually adjusting the focus.
- Is the remote control's batteries dead? Contact Media Services at mediaservices@columbiastate.edu for new batteries.

TROUBLESHOOTING CONTINUED

DVD Player (Where equipped)

- Is the power turned on?
- Is there a DVD or CD in the machine?
- The machine will not play the disc. Have you tried another disc?
- Did you press DVD on the remote control or front of the machine?
- Is the DVD machine not projecting? Check to see if the projector is turned on and the correct input source (VIDEO or DVD/VCR) is selected on the control panel.
- Is the remote control's batteries dead? Contact Instructional Technology Support Services for new batteries.
- Volume problem? Use the control panel's volume knob to adjust the sound.

ZOOM (Livestream/DVC Issues)

- Can't hear the participants? In the Zoom application, click on the arrow next to the microphone icon. Select test Speaker and Microphone. Rotate through the speaker, headphone, or other audio selections until you hear the participants. Also make sure that the participant's microphone is unmuted.
- Participants can't hear you? In the Zoom application, click on the arrow next to the microphone icon. In the Zoom application, click on the arrow next to the microphone icon. Select test Speaker and Microphone. Test the speaker and then move on to testing the microphone. Speak a few words and then pause. Zoom will play back what you said. Keep selecting other microphone choices until you are heard.
- Can't see the participants? Check the view settings. The view setting menu is found in the upper right hand corner of the Zoom application when in a meeting
- The participants can't see you? Ask them to check their view settings. The view setting menu is found in the upper right hand corner of the Zoom application when in a meeting. You should also check to see if you have the correct camera selected. In the Zoom application, click on the arrow next to the camera icon and select a camera in the list. If using an external USB camera, try unplugging the camera and plugging it back in.
- If all else fails, close the Zoom application, restart the computer, reopen the Zoom application, and restart/rejoin the meeting.
- There is more helpful information on Zoom's website at (click on the link):
<https://support.zoom.us/hc/en-us>